

MALE END VIEW

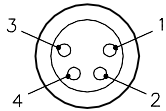

SPECIFICATIONS

CONTACT CARRIER MATERIAL/COLOR	NYLON/BLACK
CONTACT MATERIAL/PLATING	BRASS/GOLD
HOUSING MATERIAL/PLATING	BRASS/NICKEL
RATED CURRENT [A]	4.0 A
RATED VOLTAGE [V]	30 VAC/ 36 VDC
TEMPERATURE RANGE	-30°C to +80°C (-22°F to +176°F)
MAXIMUM WIRE SIZE	28 AWG

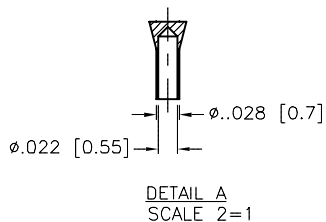
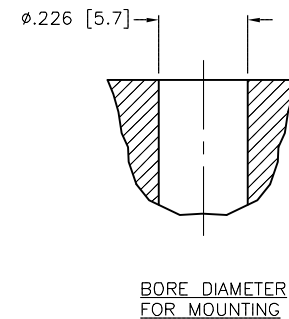
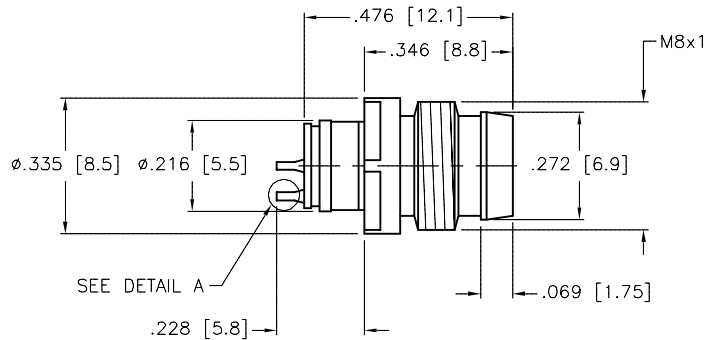
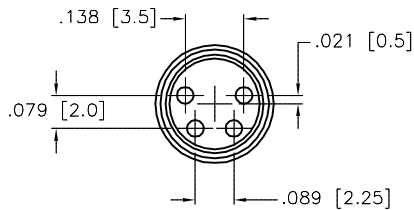

SOURCE DRAWING - FOR REFERENCE ONLY

RELATED DOCUMENTS		3RD ANGLE PROJECTION		THIS DRAWING IS CONFIDENTIAL AND THE PROPERTY OF TURCK INC. USE OF THIS DOCUMENT WITHOUT WRITTEN PERMISSION IS PROHIBITED.		3000 CAMPUS DRIVE MINNEAPOLIS, MN 55441 1-800-544-7769 (763) 553-7300 (763) 553-0708 fax www.turck.us	
1.				DRFT IK		DATE 04/14/99	
2.				APVD		SCALE 2=1.0	
3.		ALL DIMENSIONS DISPLAYED ON THIS DRAWING ARE FOR REFERENCE ONLY		UNIT OF MEASUREMENT		DESCRIPTION	
4.				INCH [MILLIMETER]		SESMS 4S (10/BAG)	
MATERIAL		CONTACT TURCK FOR MORE INFORMATION		IDENTIFICATION NO.		REV	
FINISH				E3008		A	
DO NOT SCALE THIS DRAWING		FILE: E3008		SHEET 1 OF 1			

A	DRAWING RELEASE	IK	04/14/99	
REV	DESCRIPTION	BY	DATE	ECO NO.